

REV #	DATE	DRAWN BY
1	2/2/2021	LJ

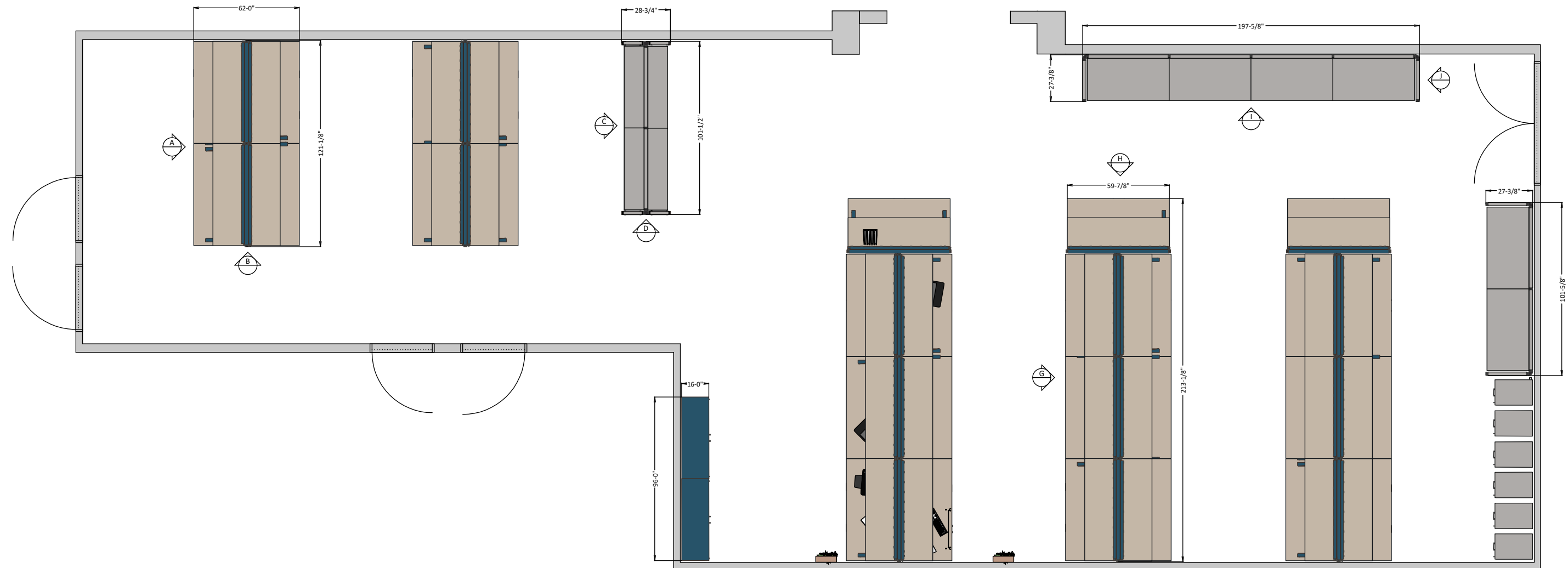

REV #	DATE	DRAWN BY
1	2/2/2021	LJ

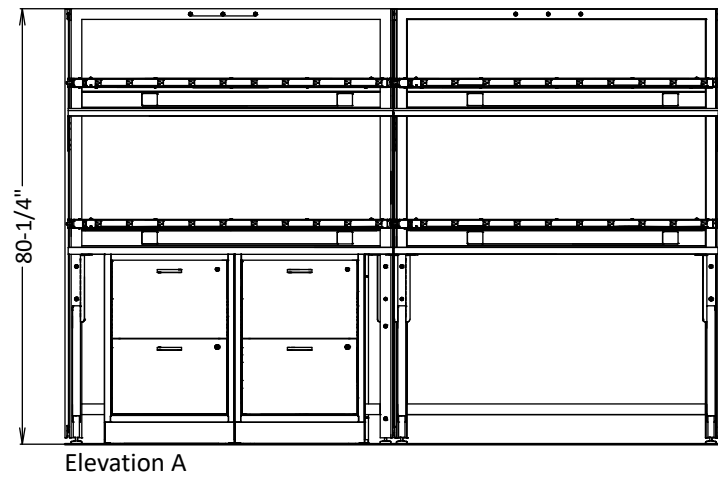

Elevation A

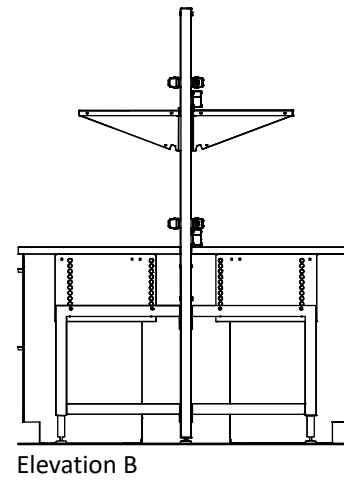

Elevation B

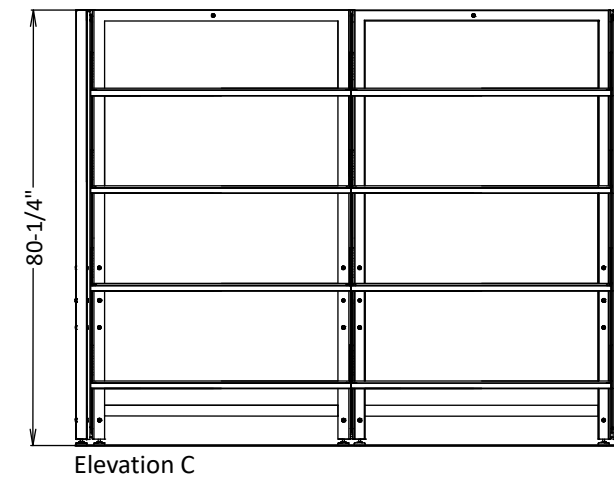

Elevation C

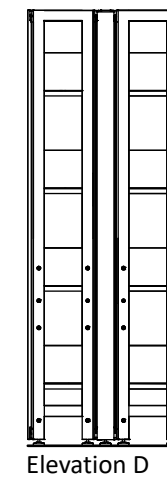

Elevation D

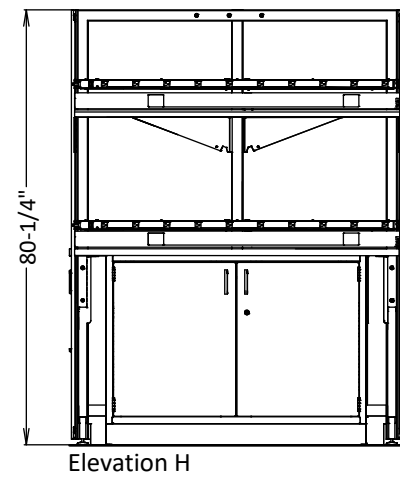

Elevation H

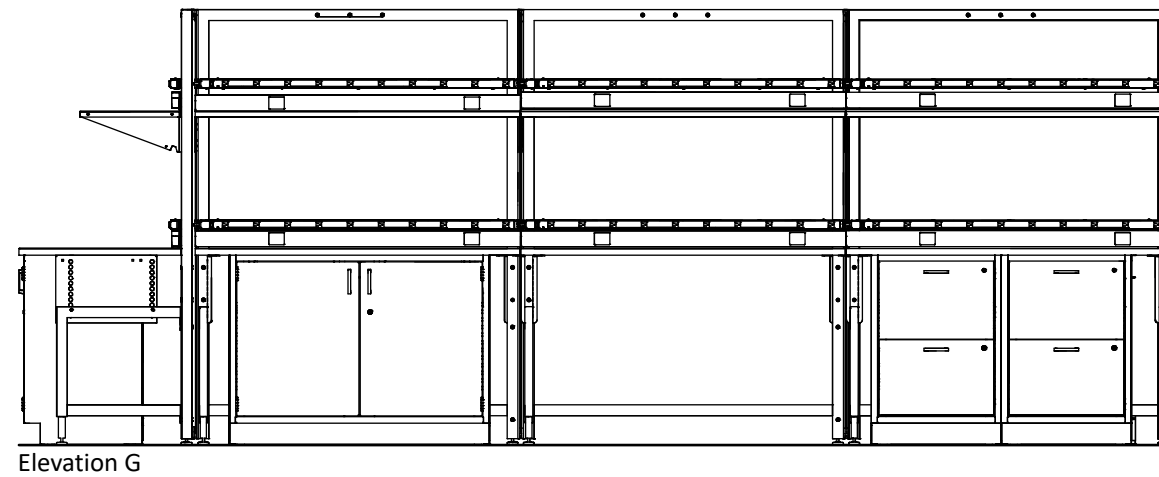

Elevation G

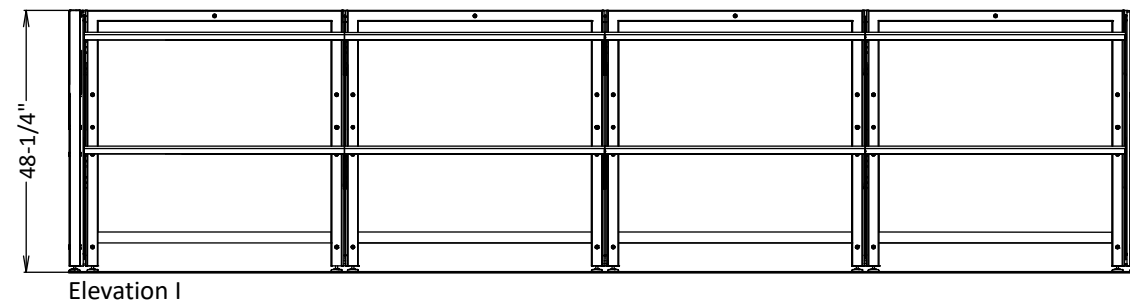

Elevation I

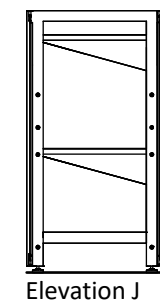

Elevation J



